

DIST	COUNTY	ROUTE	POST MILES TOTAL PROJECT	SHEET NO.	TOTAL SHEETS

Atifa Ferouz
 REGISTERED CIVIL ENGINEER
 No. C80402
 Exp. 3-31-19
 CIVIL
 STATE OF CALIFORNIA

May 31, 2018
 PLANS APPROVAL DATE
 THE STATE OF CALIFORNIA OR ITS OFFICERS OR AGENTS SHALL NOT BE RESPONSIBLE FOR THE ACCURACY OR COMPLETENESS OF SCANNED COPIES OF THIS PLAN SHEET.

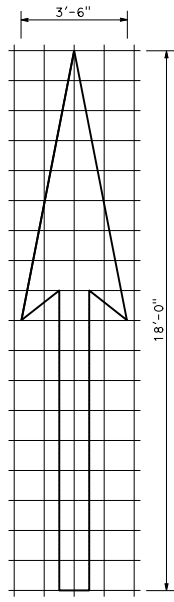

TYPE I 18'-0" ARROW

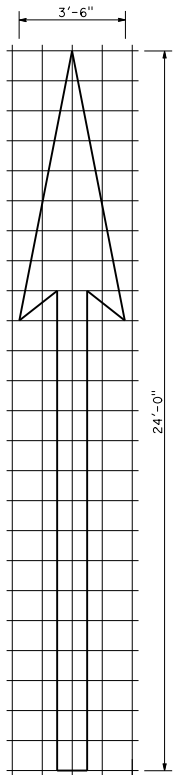

TYPE I 24'-0" ARROW

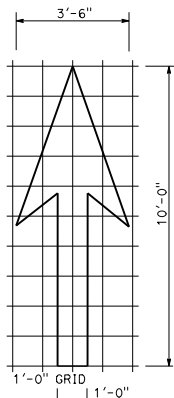

TYPE I 10'-0" ARROW

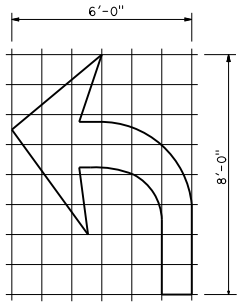

TYPE IV (L) ARROW

(For Type IV (R) arrow, use mirror image)

NOTE:
 Minor variations in dimensions may be accepted by the Engineer.

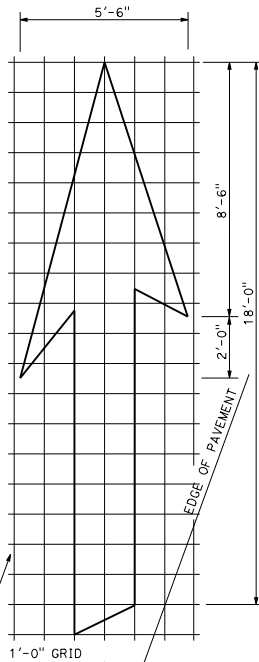

TYPE VI ARROW

Right lane drop arrow
 (For left lane, use mirror image)

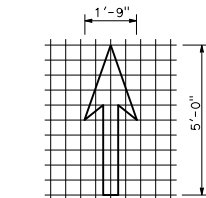

BIKE LANE ARROW

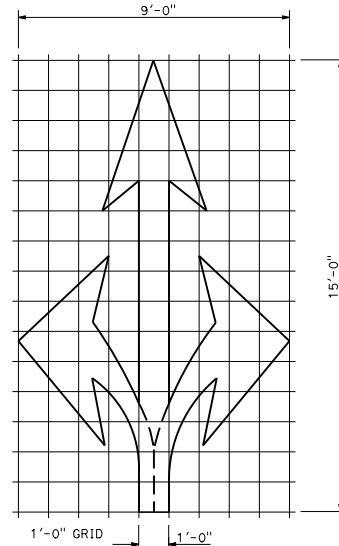

TYPE VIII ARROW

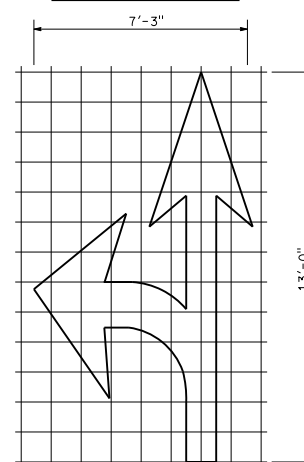

TYPE VII (L) ARROW

(For Type VII (R) arrow, use mirror image)

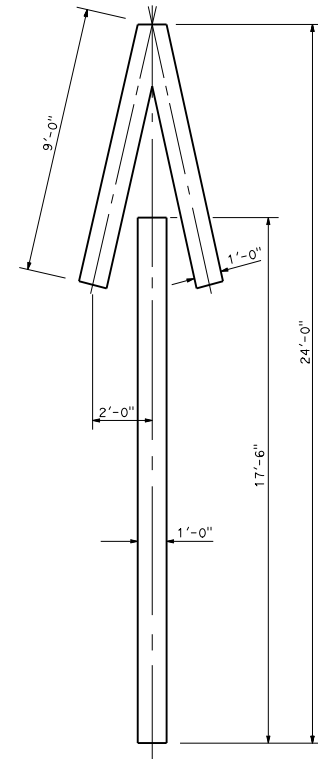

TYPE V ARROW

STATE OF CALIFORNIA
 DEPARTMENT OF TRANSPORTATION
**PAVEMENT MARKINGS
 ARROWS**

NO SCALE

A24A