

| DIST | COUNTY | ROUTE | POST MILES TOTAL PROJECT | SHEET NO. | TOTAL SHEETS |
|--|--------|-------|--------------------------|-----------|--------------|
| | | | | | |
| <i>Randell D. Hiatt</i> REGISTERED CIVIL ENGINEER | | | | | |
| May 31, 2018 PLANS APPROVAL DATE | | | | | |
| No. C60200 Exp. 6-30-19 CIVIL | | | | | |
| <small>THE STATE OF CALIFORNIA OR ITS OFFICERS OR AGENTS SHALL NOT BE RESPONSIBLE FOR THE ACCURACY OR COMPLETENESS OF SCANNED COPIES OF THIS PLAN SHEET.</small> | | | | | |

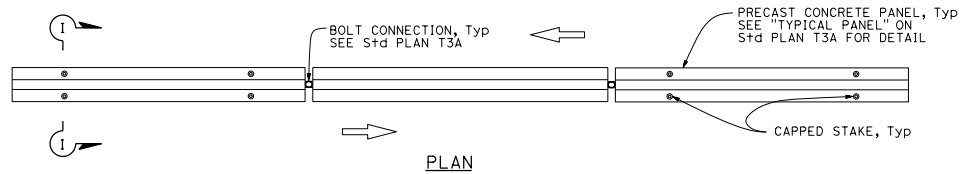

RAILING STAKING CONFIGURATION FOR TWO-WAY TRAFFIC

See Note 2

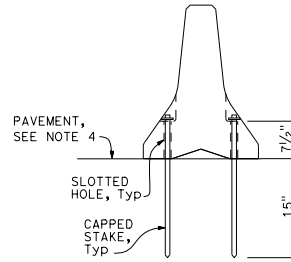

SECTION I-I

NOTES:

1. Where Type K Temporary Railing is placed on curves and radii that are too severe to connect panels with bolted joints, the railing must be backed continuously with earth fill. See Section F-F.
2. Where Type K Temporary Railing is placed as a temporary or long term barrier in two-way traffic on highways with less than 24" from the edge of traveled way, use four capped stakes per every other panel with end panels staked.
3. Where Type K Temporary Railing is placed 3" to 24" from the edge of an excavation on highways, use two capped stakes per panel along the traffic side.
4. Staked Type K Temporary Railing must be supported by at least 4" thick concrete, hot mix asphalt or existing asphalt concrete pavement.
5. The minimum yield strength for the washer must be 60,000 psi.

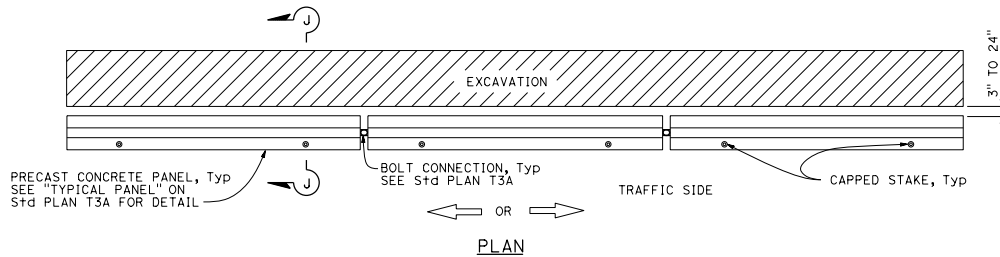

RAILING STAKING CONFIGURATION ADJACENT TO AN EXCAVATION

See Note 3

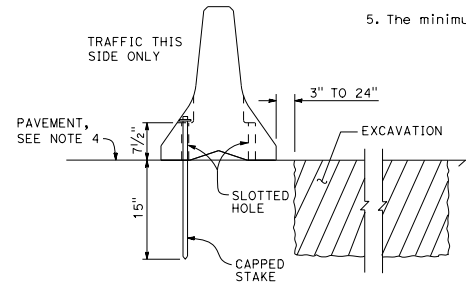

SECTION J-J

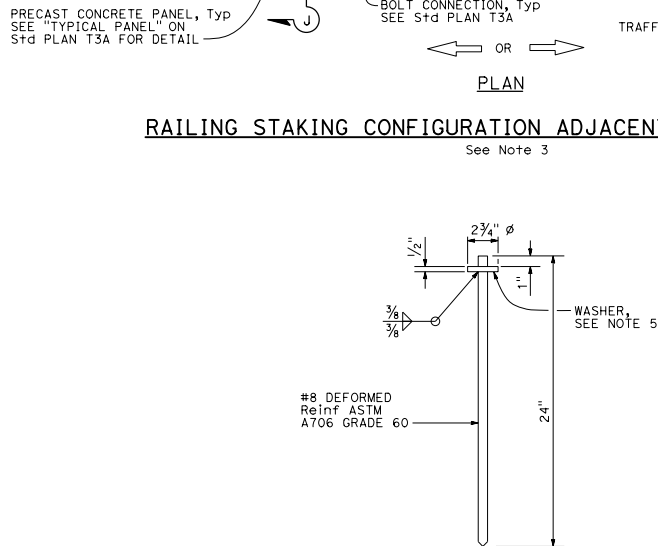

CAPPED STAKE DETAIL

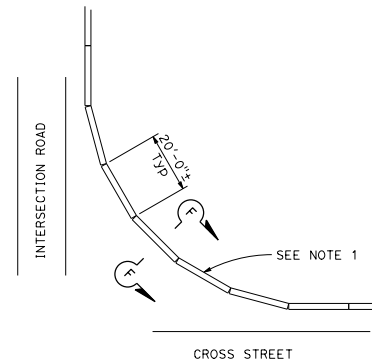

CURVED LAYOUT

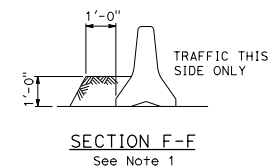

SECTION F-F
See Note 1

STATE OF CALIFORNIA
DEPARTMENT OF TRANSPORTATION

**TEMPORARY RAILING
(TYPE K)**

NO SCALE

T3B

2018 STANDARD PLAN T3B

282