

Dist	COUNTY	ROUTE	POST MILES TOTAL PROJECT	SHEET TOTAL SHEETS
<b>Randell D. Hiatt</b> REGISTERED CIVIL ENGINEER				
May 31, 2018 PLANS APPROVAL DATE				
No. C50200 Exp. 6-30-19 CIVIL				
THE STATE OF CALIFORNIA OR ITS OFFICERS OR AGENTS SHALL NOT BE RESPONSIBLE FOR THE ACCURACY OR COMPLETENESS OF SCANNED COPIES OF THIS PLAN SHEET.				

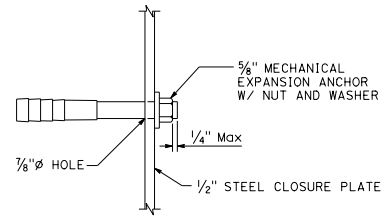

**CLOSURE PLATE ANCHOR BOLT DETAIL**

**NOTE:**  
 1. If lifting holes are used with the concrete connector, they shall conform to the lifting hole details shown on Standard Plan T3A.

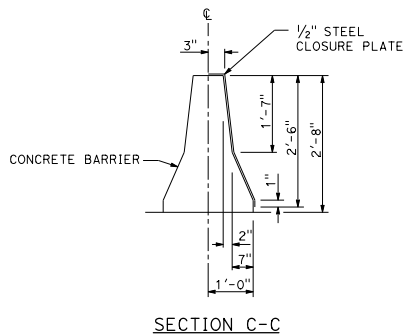
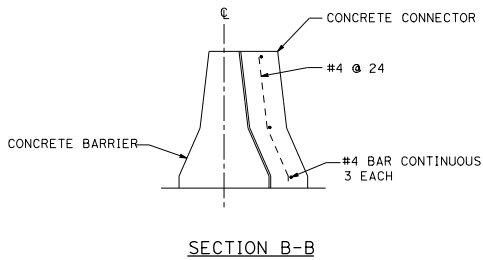
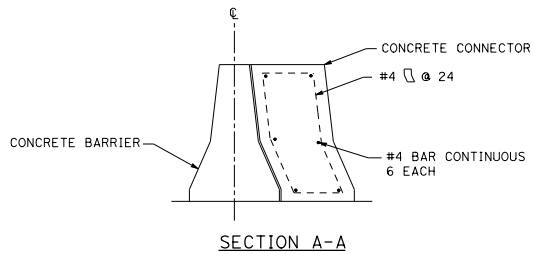
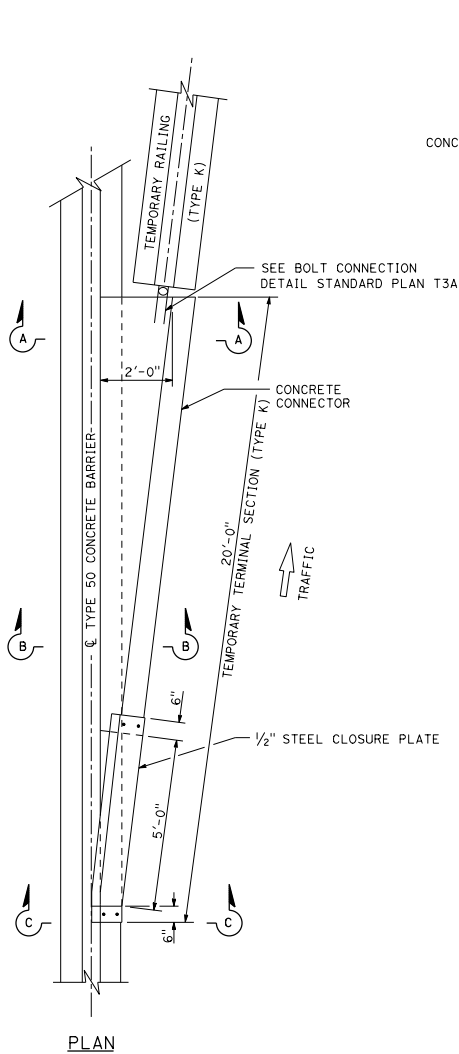
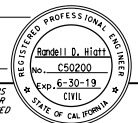
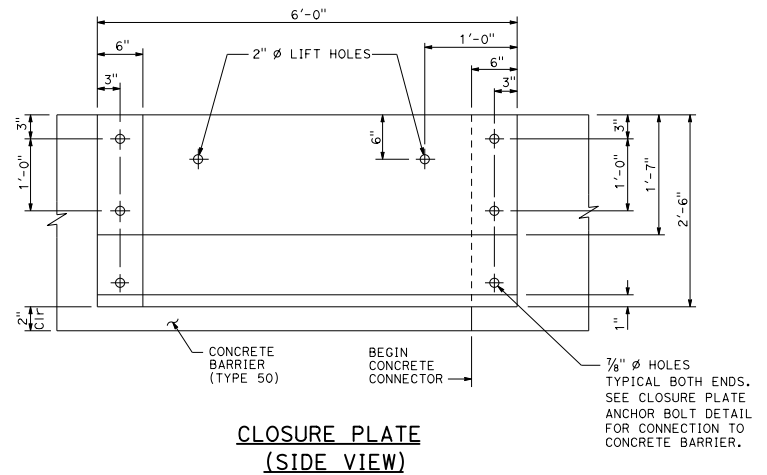

**CLOSURE PLATE (SIDE VIEW)**

STATE OF CALIFORNIA  
 DEPARTMENT OF TRANSPORTATION  
**TEMPORARY TERMINAL SECTION (TYPE K)**

NO SCALE

**T5**